



DATOS MOTOR

POTENCIA	0.33HP
REVOLUCIONES	1760
FRECUENCIA	60HZ
TORQUE MOTOR NOMINAL	1,4
CARCASA (PAM)	63(B5)
TIPO BRIDA	FF-115
EFICIENCIA MOTOR	IE 2

DATOS REDUCTOR

REFERENCIA	541014
TIPO	ORTOGONAL
MODELO	FCN
MATERIAL	ALUMINIO
CARCASA	50
RELACION DE TRANSMISION i:	60
VELOCIDAD SALIDA	29,33
TORQUE MAXIMO	68
TORQUE OPERACIÓN	49
FACTOR DE SERVICIO	1,4

PLANOS REDUCTOR

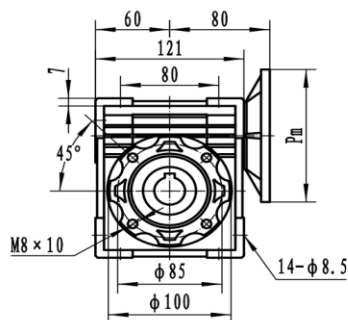

FCN 50

Input shaft hole

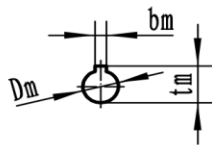

Output shaft hole

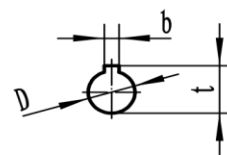

Dimensions of output shaft				
D	H7	b	D10	t
2.5		8		28.3

	Pm	Dm	bm	tm
63B5	140	11	4	12.8
63B14	90			
71B5	160	14	5	16.3
71B14	105			
80B5	200	19	6	21.8
80B14	120			

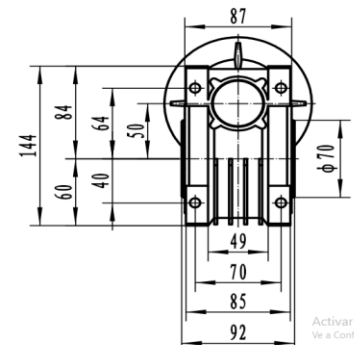

Activar? Ve a Cont